

Z1 ARMADA/QX56 MASTER HOSE SET INSTALLATION MANUAL

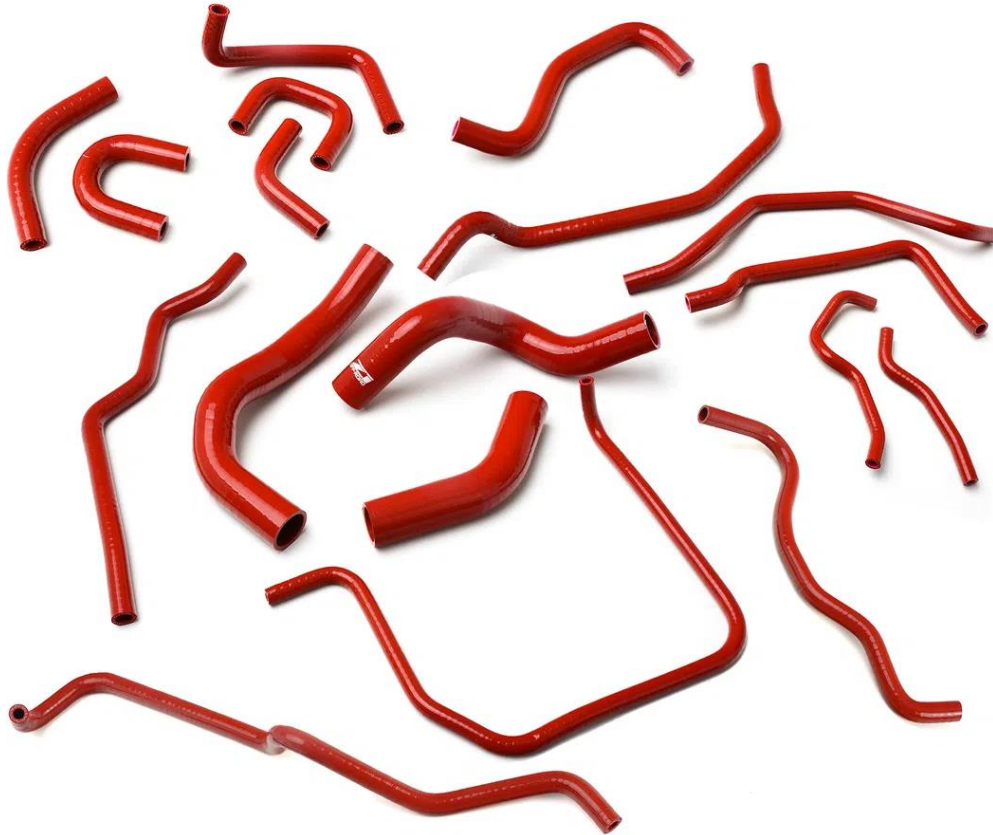

This Installation Manual is intended for the following models:

2004-2015	Nissan Armada (TA60)
2004-2010	Infiniti QX56 (JA60)

PROLOGUE:

Study these instructions completely before proceeding to assembly. The installer must have a thorough knowledge of automotive systems operation. If unfamiliar with any of the concepts outlined in this instruction, we recommend the installation be completed by a qualified professional.

WARNING!

Extreme caution should be taken when performing maintenance or performance upgrades to your vehicle. Please observe and abide by any Warning or Caution labels placed on the various components and tools used when servicing your vehicle. If you have any questions regarding installation or the various components included with the Z1 Off-Road Armada/QX56 Master Hose Kit, consult with a Professional Mechanic, or contact Z1 Off-Road for more information.

PARTS INCLUDED:

Item	Quantity	Description
1	4	PCV Hose
2	2	Water Outlet Coolant Hose
3	3	Oil Cooler Hose
4	5	Radiator Hose
5	1	Brake Booster Hose
6	2	Power Steering Hose
7	1	Heater Hose

SAFETY REQUIREMENTS:

- Always wear safety glasses and any necessary protective garments. If using any fluids, chemicals, or solvents, a respirator is recommended.
- Always use properly rated jack stands when working under your vehicle.
- Always keep limbs and parts away from moving drivetrain parts.
- Always turn the ignition to the OFF position and disconnect the NEGATIVE battery terminal.
- Only operate drivetrain in safe space and well-ventilated areas.

BEFORE YOU BEGIN:

Remove contents from the Z1 Off-Road Armada/QX56 Master Hose Set and verify that ALL necessary hardware is present.

TABLE OF CONTENTS:

PCV HOSE SET:4
WATER OUTLET COOLANT HOSE SET:.....5
OIL COOLER HOSE SET:.....6
RADIATOR HOSE SET:7
BRAKE BOOSTER HOSE:8
POWER STEERING HOSE SET:9
HEATER HOSE SET: 10

PCV HOSE SET:

1. Locate the Z1 PCV Hose Set, containing (3) three hoses, shown below in *Figure 1*.



Figure 1

2. Remove the OE PCV Hoses, and replace them with the Z1 PCV Hoses according to *Figure 1* above and *Figure 2* below.

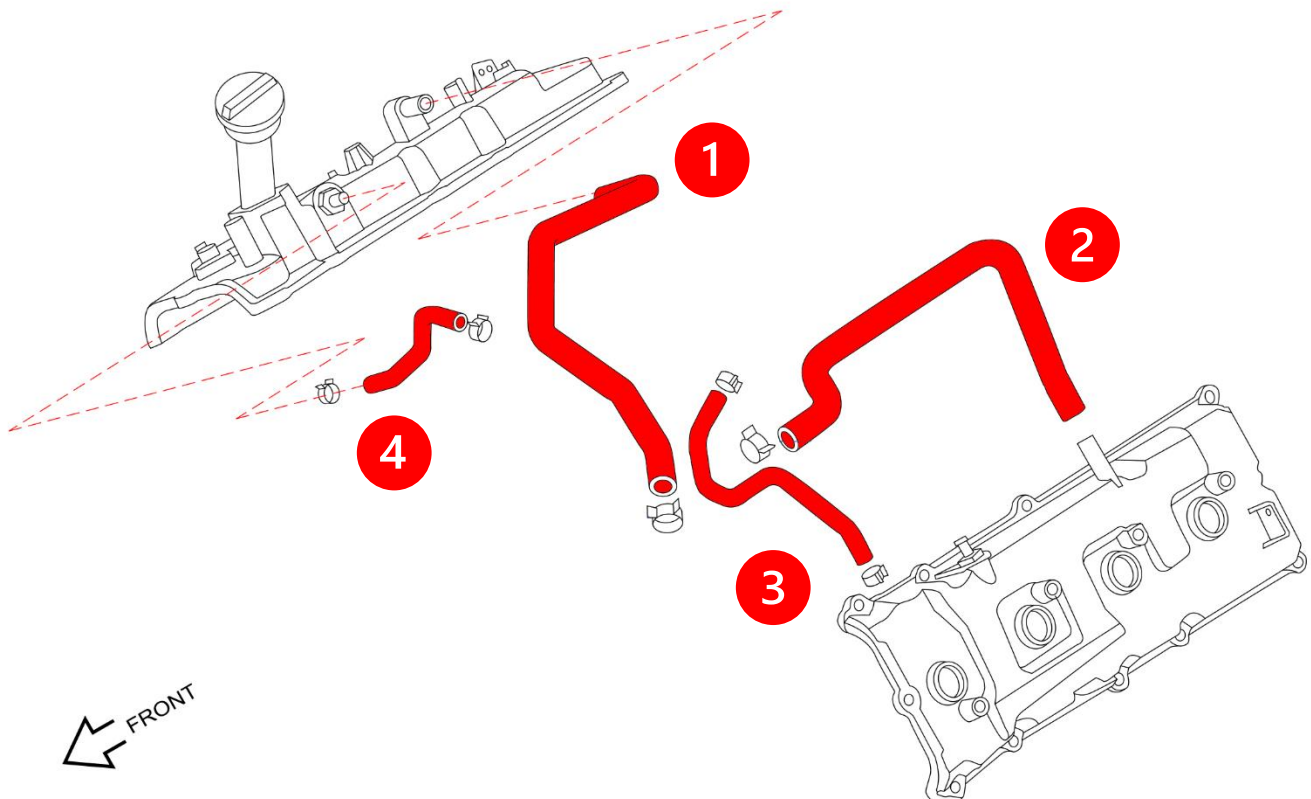

Figure 2

WATER OUTLET COOLANT HOSE SET:

3. Locate the Z1 Water Outlet Coolant Hose Set, containing (2) two hoses, shown below in *Figure 3*.



Figure 3

4. Remove the OE Coolant Hoses on the front of the engine, and replace them with the Z1 Coolant Hoses according to *Figure 3* above and *Figure 4* below. Refill coolant and bleed the Coolant System in accordance with the Factory Service Manual.

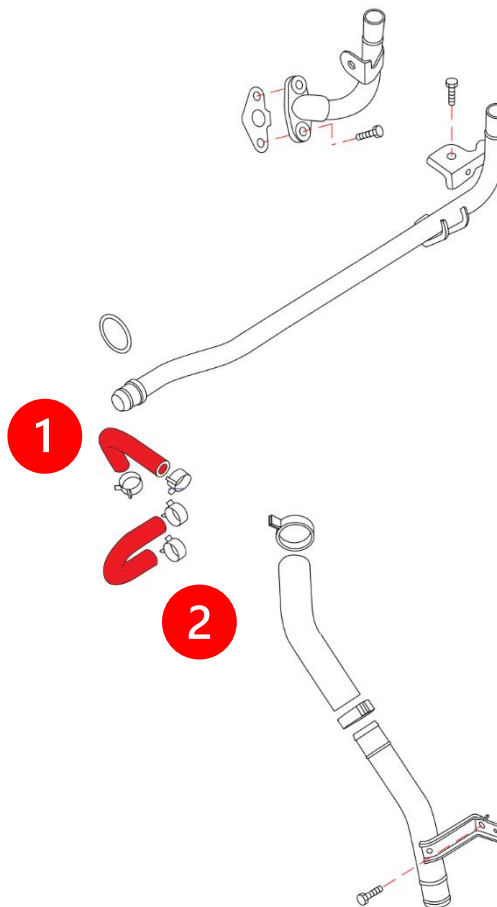

Figure 4

OIL COOLER HOSE SET:

6. Locate the Z1 Oil Cooler Hose Set, containing (3) three hoses, shown below in *Figure 5*.

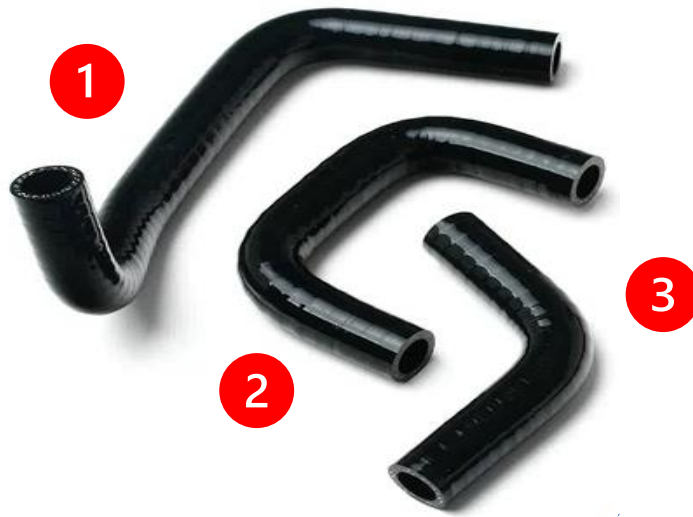

Figure 5

7. Remove the OE Oil Cooler Hoses, and replace them with the Z1 Oil Cooler Hoses according to *Figure 5* above and *Figure 6* below. Refill coolant and bleed the Coolant System in accordance with the Factory Service Manual.

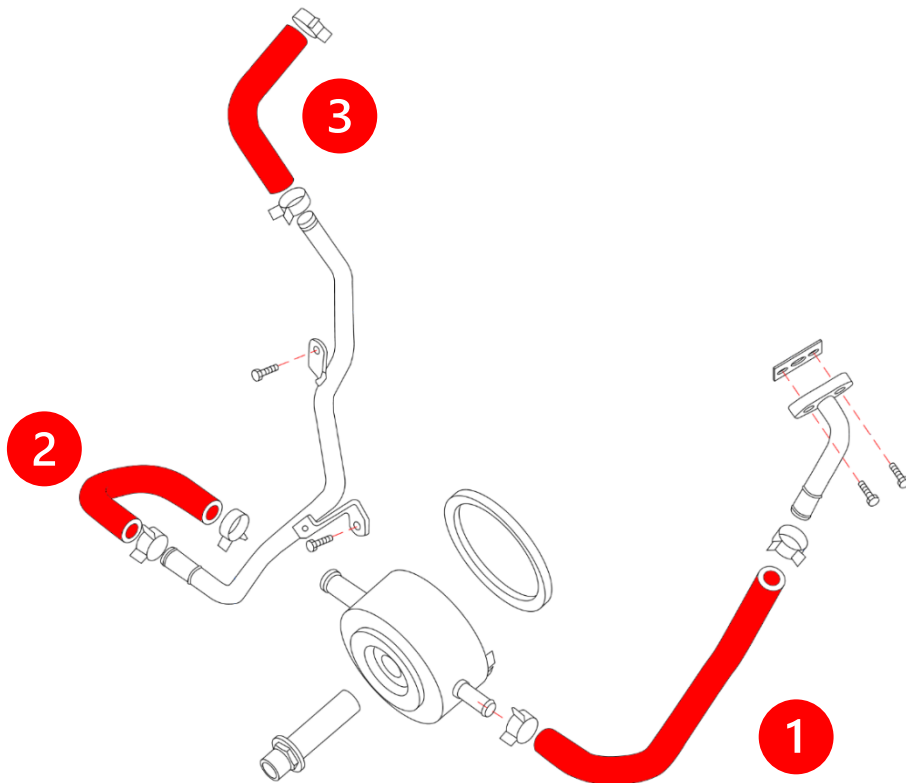

Figure 6

RADIATOR HOSE SET:

8. Locate the Z1 Radiator Hose Set, containing (5) five hoses, shown below in *Figure 7*.



Figure 7

9. Remove the OE Radiator Hoses, and replace them with the Z1 Radiator Hoses according to *Figure 7* above and *Figure 8* below. Bleed the Cooling System in accordance with the Factory Service Manual.

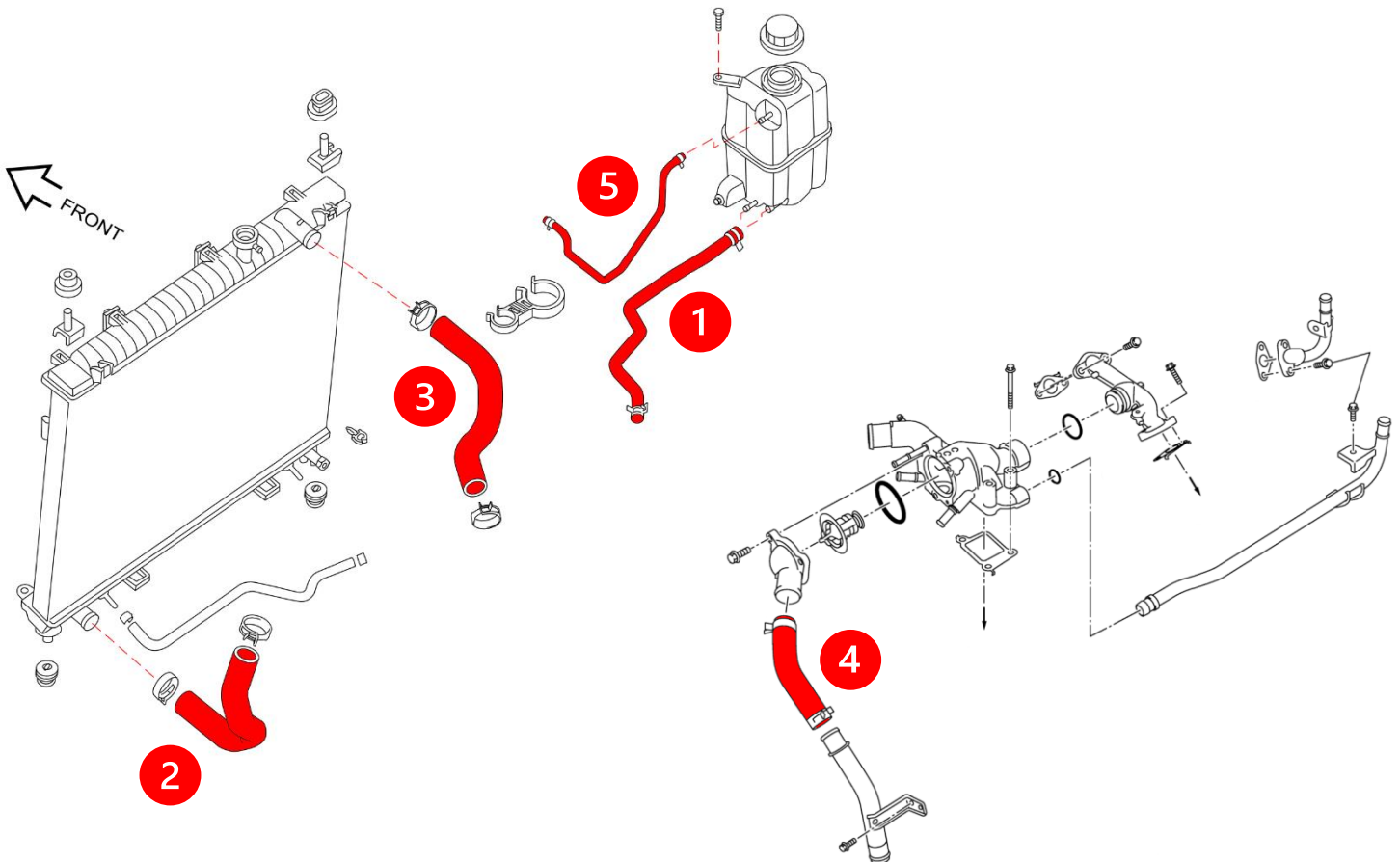

Figure 8

BRAKE BOOSTER HOSE:

10. Locate the Z1 Brake Booster Hose, shown below in *Figure 9*.



Figure 9

11. Remove the OE Brake Booster Hose, and replace it with the Z1 Brake Booster Hose according to *Figure 9* above and *Figure 10* below.

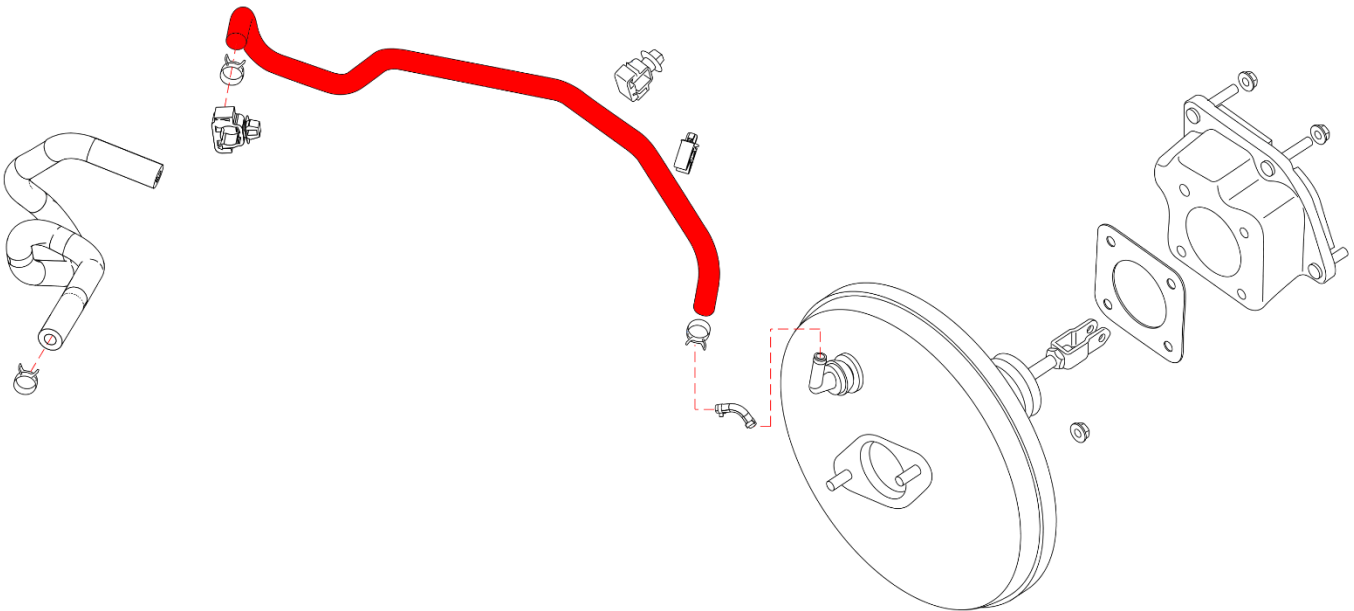

Figure 10

POWER STEERING HOSE SET:

12. Locate the Z1 Power Steering Hose Set, containing (2) two hoses, shown below in *Figure 11*.



Figure 11

13. Remove the OE Power Steering Hoses, and replace them with the Z1 Power Steering Hoses according to *Figure 11* above and *Figure 12* below. Bleed the Power Steering System in accordance with the Factory Service Manual.

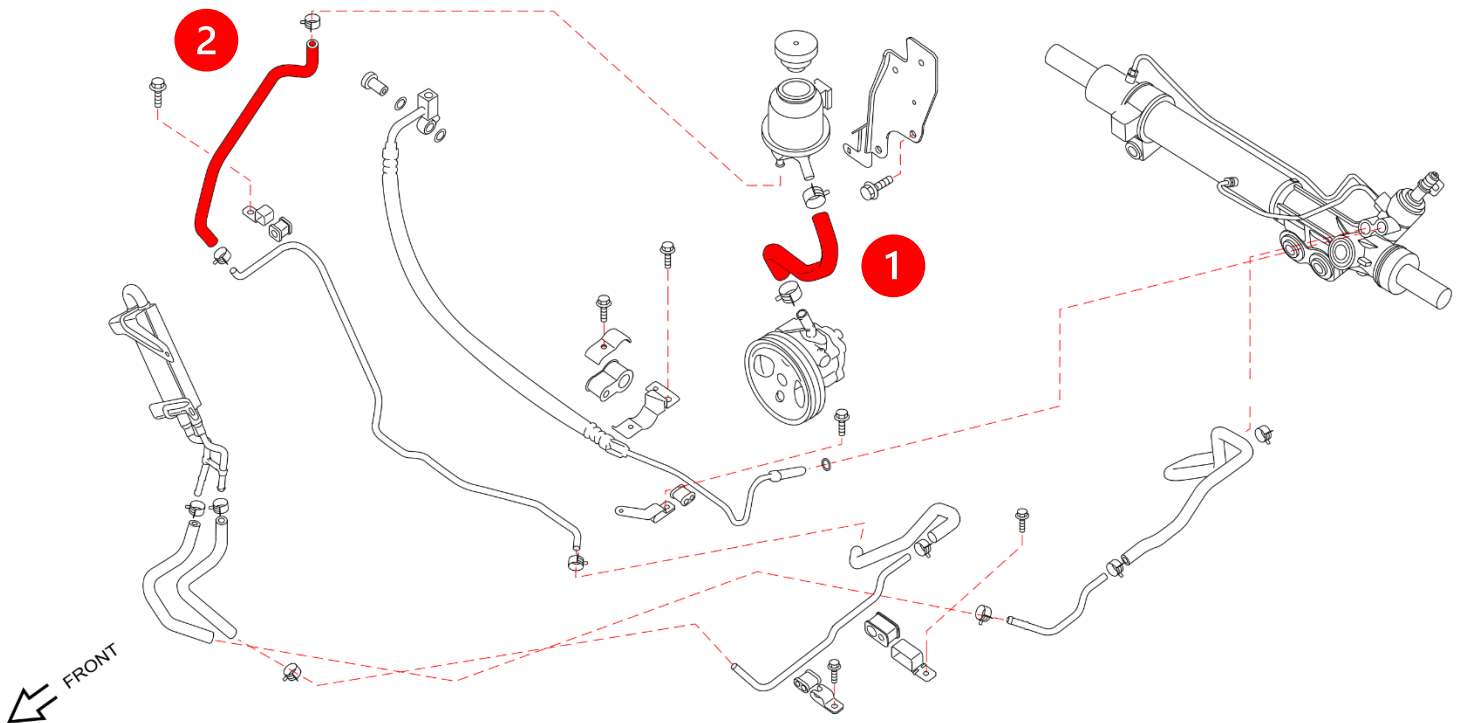

Figure 12

HEATER HOSE SET:

14. Locate the Z1 Heater Hose Set, containing (1) one hose, shown below in *Figure 13*.



Figure 13

15. Remove the OE Heater Hoses, and replace them with the Z1 Heater Hoses according to *Figure 13* above and *Figure 14* below. Refill and bleed the Coolant System in accordance with the Factory Service Manual.

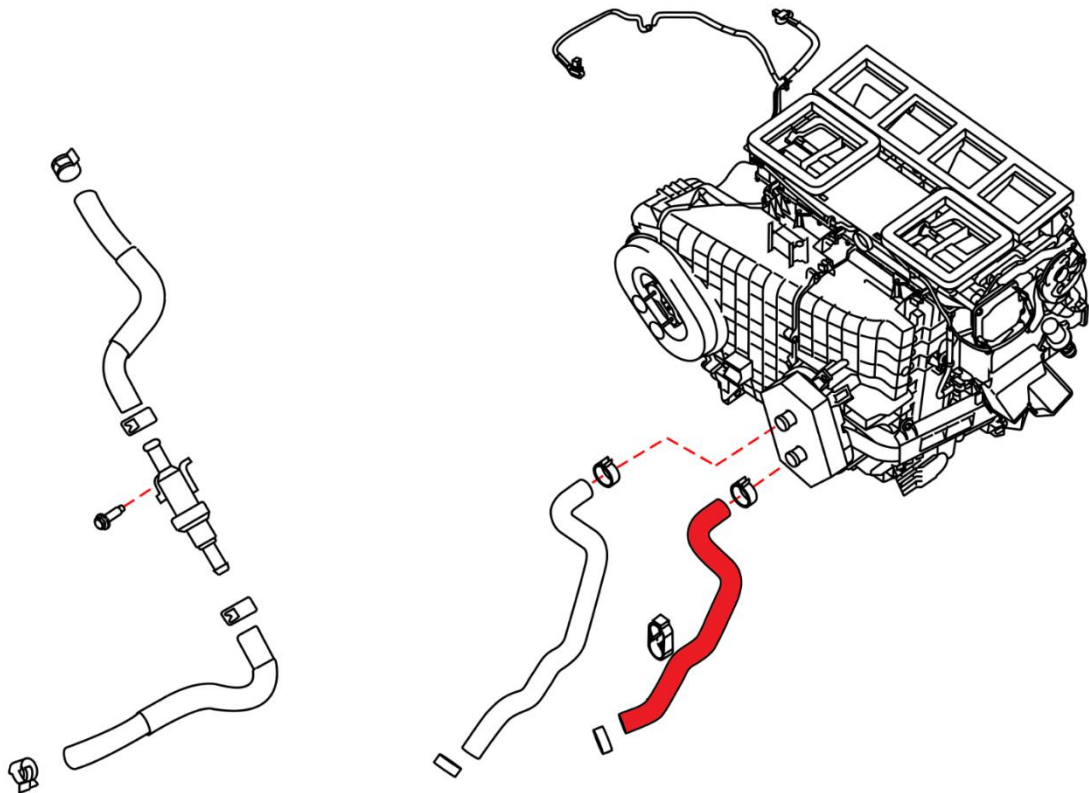

Figure 14

END

Additional Technical Support:
Contact Z1 Off-Road at info@z1offroad.com
Or call 678-839-8019 between 9am and 6pm ET